

## WHAT STYLES OF ARCHES ARE AVAILABLE?

Timber arches were traditionally used to provide visual accents to long passages, divide larger rooms or define the family areas from the rooms used by visitors. Many old houses were built with decorative screens or arches in entrance halls and other rooms, which have often been removed or altered over the years. Their restoration will help to revive the character of the interior of a house. Arches are generally in one of three styles

### Georgian

Georgian archways generally pre-date the turn of the 20th Century and were simple timber reconstructions of classical masonry arches.

### Federation/Bungalow

Federation style archways are typically vertical timber slats within a curved frame, progressively becoming simpler, straighter and more angular as the Californian Bungalow influence was felt.

### Art Nouveau.

Art Nouveau arches were popular in the Edwardian period and typically involved elaborate curvilinear fretworks and asymmetrical designs.

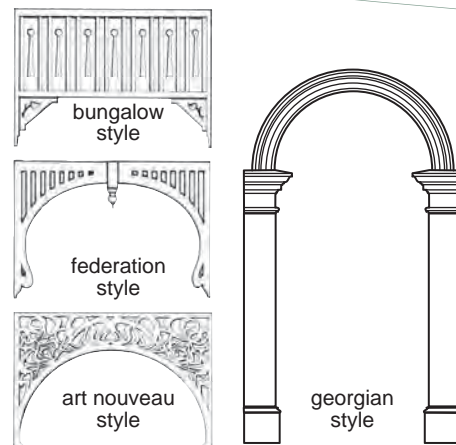

## WHERE AND HOW ARE THEY INSTALLED?

Archway openings were traditionally formed exactly the same as doorway openings. They were lined with jambs and had architraves fitted both sides. They were usually constructed the same height as all other openings to a height of approx 2550mm. The arches themselves were then simply skew nailed into position. These days 'no more nails' adhesive is more common but the positioning and lining details should be duplicated for the best result. For wider openings the arch is split in the centre and an extension piece is added to the width required. The joints are covered by the keyblocks. There are a range of extensions piece designs available to individualize the arch or match other details pre existing in the house.

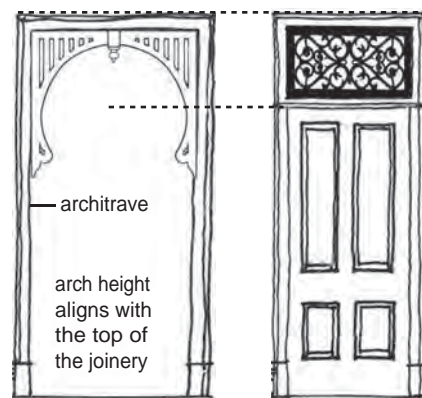

## WHAT ARE THEY MADE OF?

Woodworkers make arches in a variety of materials for different applications. For flush style arches that are to be painted, laser cut 32mm MDF is preferred as it will not delaminate. Special care must be taken with the fixing of MDF as nails will usually split the material. Adhesive fixing is preferred. For rebated style arches, Woodworkers carry Pacific Maple arches in stock in most designs as it closely approximates the look of the Queensland Maple which was used in many original arches. We also custom manufacture in Red Cedar where clear finishing is required or where weather exposure is an issue. For all external applications, the durability of cedar is essential.

## WHAT'S TO KNOW ABOUT VERANDAH BRACKETS?

Decorative Verandah Brackets or 'sweeps' are traditionally used to embellish house facades. Chronologically, brackets only became popular from the 1880's with many of the original designs serving for many decades. The fretworked foliage designs typical of the colonial era were occasionally interlaced with sinuous art nouveau patterns on more avant garde houses. In the early twentieth century, simpler more geometric brackets became most common with larger, more vertical designs being in vogue from the 1920's. Brackets serve no structural purpose but are exposed to continual weather and therefore require to be made of durable material. For over 80 years Woodworkers has been cutting brackets in red cedar. We cut them one at a time by hand in the traditional way using offcuts from our joinery operations. Consequently cutting brackets to match existing examples simply requires the provision of an original bracket or a cardboard template. Most brackets are 32mm thick but this can be varied if required. Our brackets are more durable, authentic & cheaper than laser cut pine alternatives.

## HOW SHOULD THEY BE INSTALLED?

Until the late 1920s verandah brackets formed part of a suite of mouldings and fretworks atop each column that served to accentuate and decorate the verandah 'skirts' of the cottage. Columns were commonly stop chamfered between the handrail and the collar moulds. A short space above the collars was the crown moulds which provided the seat for the fretworked verandah brackets. Woodworkers carry precut collar and crown moulds for 100 x 100 columns and has lengths of the same moulds for other size columns. Always thoroughly paint verandah brackets before fixing them so that they are fully sealed even on their concealed faces. They are best fixed with galvanised screws or zinc coated gun nails. From the latter 1920s, verandah brackets grew larger and extended down the columns eliminating the use of collar and crown moulds. Occasionally the sweeps formed part of, or were incorporated into full verandah arches that fully framed the lintels between columns. Verandah brackets fell from favour in the mid 1930s as buildings generally became more austere. Brackets were often removed during modernisations but the scars left behind can give a clue to the size and positioning of the original column decoration.

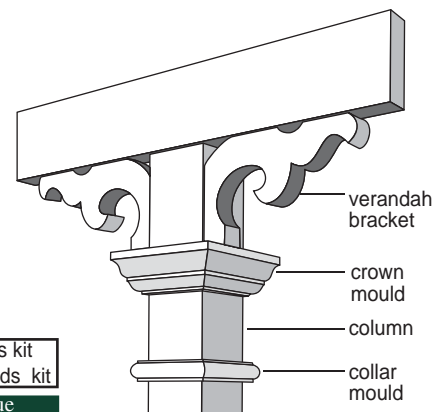
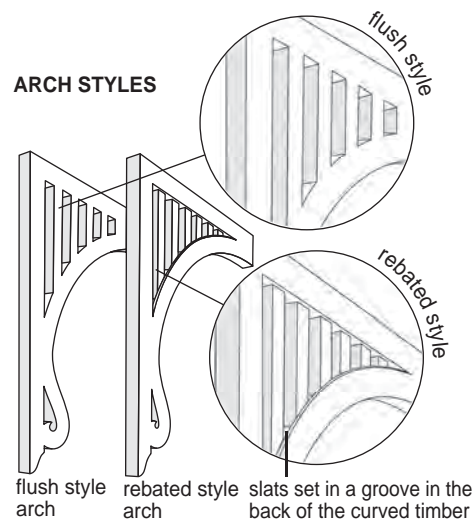

**we've been making original arches & brackets since 1928.**

for 100 x 100 posts pre-cut crown moulds kit & pre-cut collar moulds kit  
prices in our product catalogue

Website: [www.woodworkers.com.au](http://www.woodworkers.com.au)

Email: [sales@woodworkers.com.au](mailto:sales@woodworkers.com.au)



**BRISBANE**  
1095 Ipswich Rd  
Moorooka 4105  
☎ 07 3848 1383  
F: 07 3892 1476

**GOLD COAST**  
Warehouse Road  
Southport 4215  
☎ 07 5571 0088  
F: 07 5571 0617

**SUNCOAST**  
53 Wisers Road  
Maroochydore  
☎ 07 5479 0999  
F: 07 5479 0911

**SYDNEY**  
2 Sydenham Rd  
Brookvale 2100  
☎ 02 9938 4999  
F: 02 9938 4666

# 15 PEDESTAL ARCHES

The current version of this document is on the internet. Printed version & prices may be superseded. All material subject to copyright.

Colonial houses built in the late Nineteenth and early Twentieth Century typically used ornate timber pedestal arches and grilles to divide living spaces.

The Woodworkers Company builds arches which replicate measured originals. They are either preprimed white timber or, where varnishing is preferred Red Cedar is used. For renovations or new developments we are always ready to build designs that blend comfortably with the architectural style or meet particular specifications.

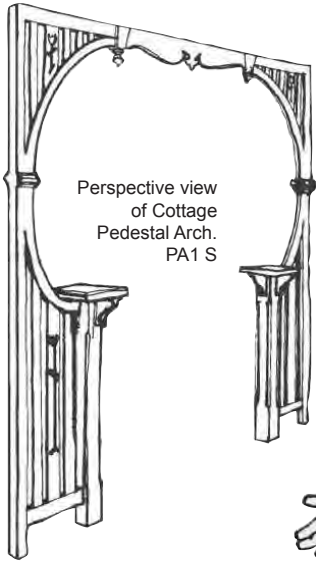

Perspective view of Cottage Pedestal Arch. PA1 S

Our stock White Primed Federation Pedestal Arches are super value and come fully prepared for top coats



## ARCH PRICES

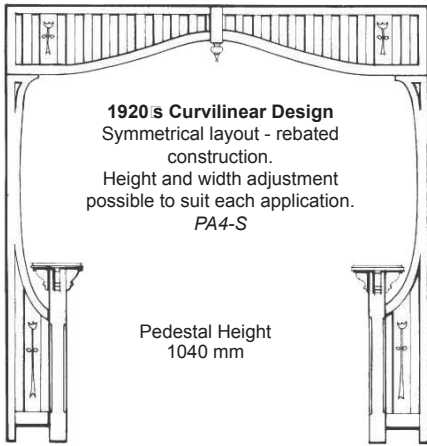

**1920's Curvilinear Design**  
Symmetrical layout - rebated construction.  
Height and width adjustment possible to suit each application.  
PA4-S

Pedestal Height 1040 mm

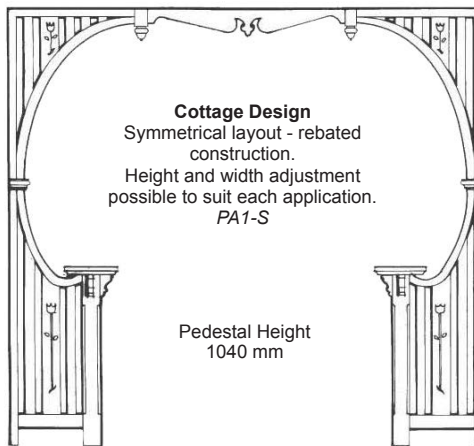

**Cottage Design**  
Symmetrical layout - rebated construction.  
Height and width adjustment possible to suit each application.  
PA1-S

Pedestal Height 1040 mm

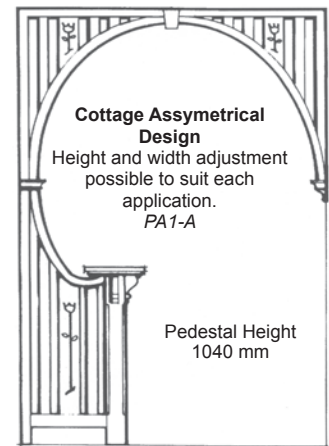

**Cottage Assymetrical Design**  
Height and width adjustment possible to suit each application.  
PA1-A

Pedestal Height 1040 mm

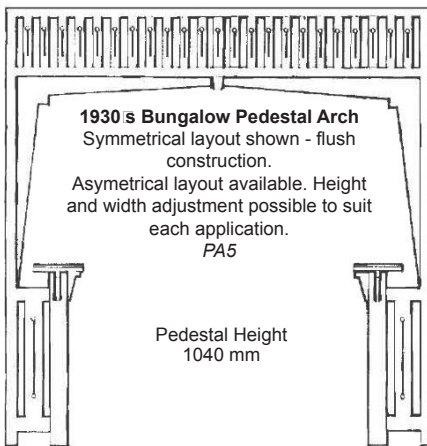

**1930's Bungalow Pedestal Arch**  
Symmetrical layout shown - flush construction.  
Asymmetrical layout available. Height and width adjustment possible to suit each application.  
PA5

Pedestal Height 1040 mm

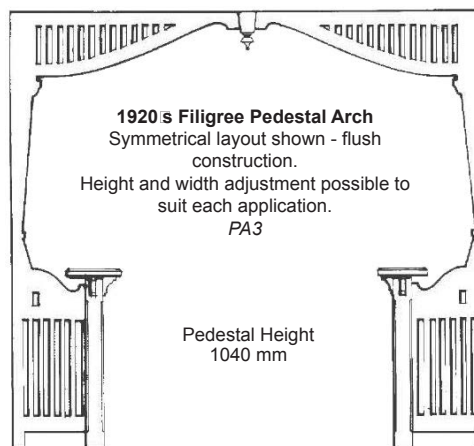

**1920's Filigree Pedestal Arch**  
Symmetrical layout shown - flush construction.  
Height and width adjustment possible to suit each application.  
PA3

Pedestal Height 1040 mm

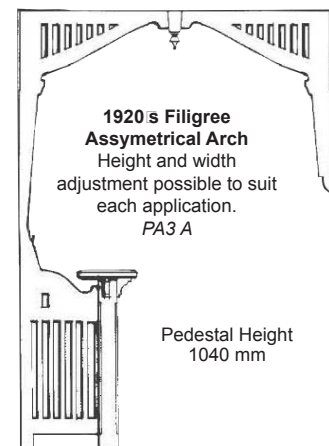

**1920's Filigree Assymetrical Arch**  
Height and width adjustment possible to suit each application.  
PA3 A

Pedestal Height 1040 mm

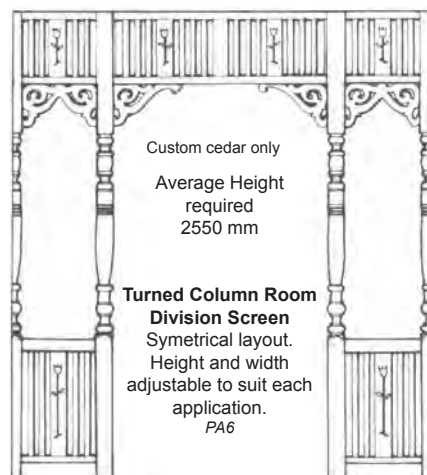

Custom cedar only  
Average Height required 2550 mm

**Turned Column Room Division Screen**  
Symmetrical layout.  
Height and width adjustable to suit each application.  
PA6

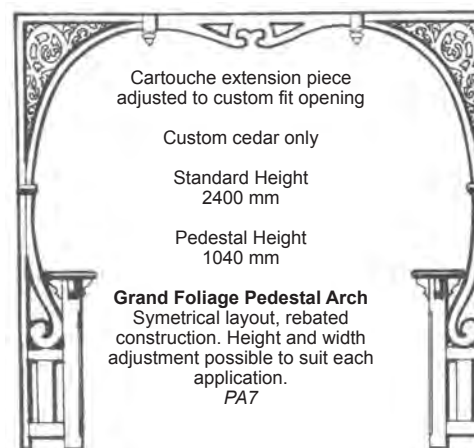

Cartouche extension piece adjusted to custom fit opening

Custom cedar only

Standard Height 2400 mm

Pedestal Height 1040 mm

**Grand Foliage Pedestal Arch**  
Symmetrical layout, rebated construction. Height and width adjustment possible to suit each application.  
PA7

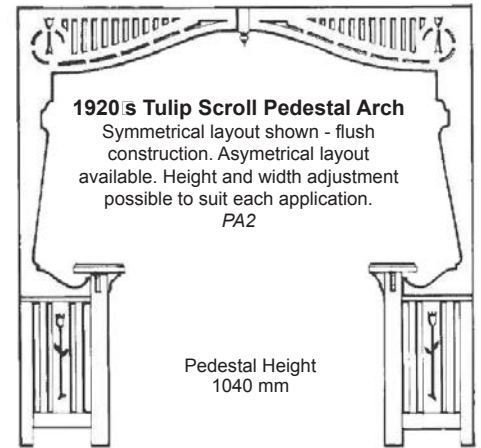

**1920's Tulip Scroll Pedestal Arch**  
Symmetrical layout shown - flush construction. Asymmetrical layout available. Height and width adjustment possible to suit each application.  
PA2

Pedestal Height 1040 mm

# 15 HALLWAY ARCHES

The current version of this document is on the internet. Printed version & prices may be superseded. All material subject to copyright.

## COTTAGE HALLWAY SERIES

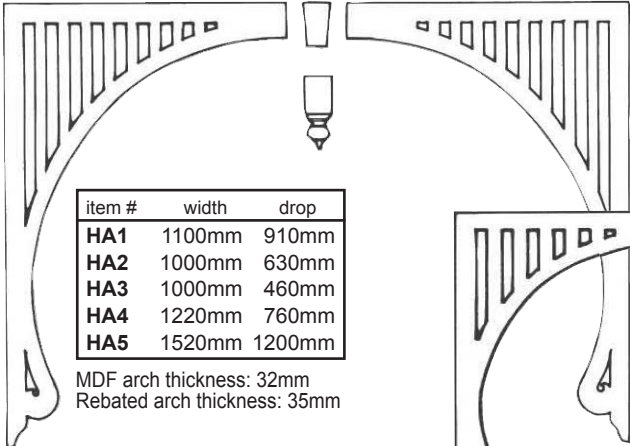

item #	width	drop
HA1	1100mm	910mm
HA2	1000mm	630mm
HA3	1000mm	460mm
HA4	1220mm	760mm
HA5	1520mm	1200mm

MDF arch thickness: 32mm  
Rebated arch thickness: 35mm

**HA5 - Type 5 Cottage Hallway Arch**  
Tapered Keyblock or Turned Finial available.

**HA1 - Type 1 Cottage Hallway Arch**

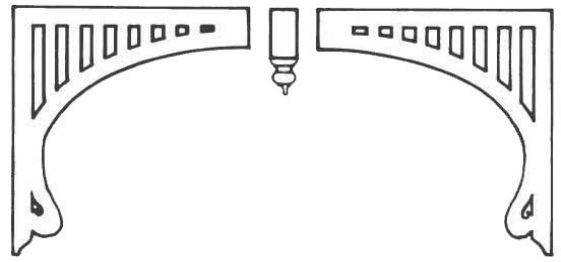

**HA4 - Type 4 Cottage Hallway Arch**  
Tapered Keyblock or Turned Finial available.

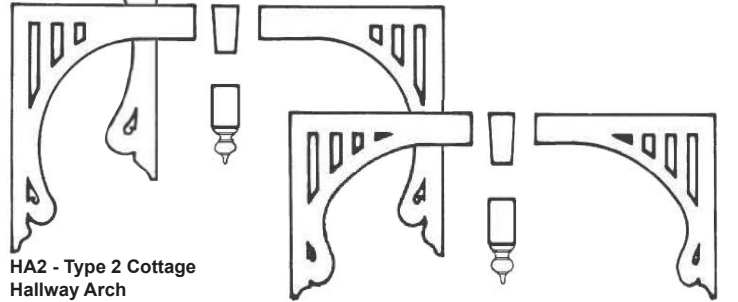

**HA2 - Type 2 Cottage Hallway Arch**  
Tapered Keyblock or Turned Finial available.

**HA3 - Type 3 Cottage Hallway Arch**  
Tapered Keyblock or Turned Finial available.

## COLONIAL FOLIAGE SERIES

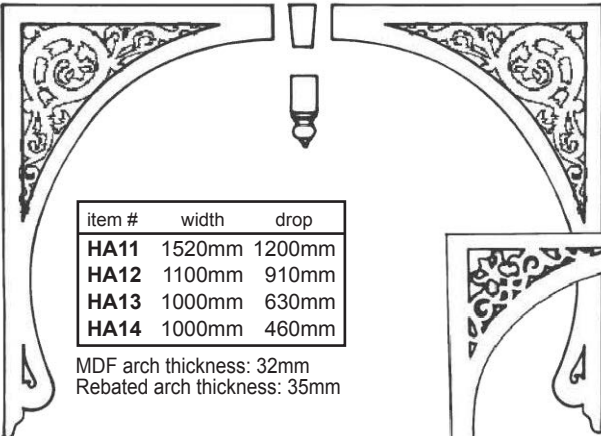

item #	width	drop
HA11	1520mm	1200mm
HA12	1100mm	910mm
HA13	1000mm	630mm
HA14	1000mm	460mm

MDF arch thickness: 32mm  
Rebated arch thickness: 35mm

**HA11 - Grand Colonial Foliage Hallway Arch**  
Tapered keyblock or Turned Finial available.

**HA12 - Large Colonial Foliage Hallway Arch**  
Tapered keyblock or Turned Finial available.

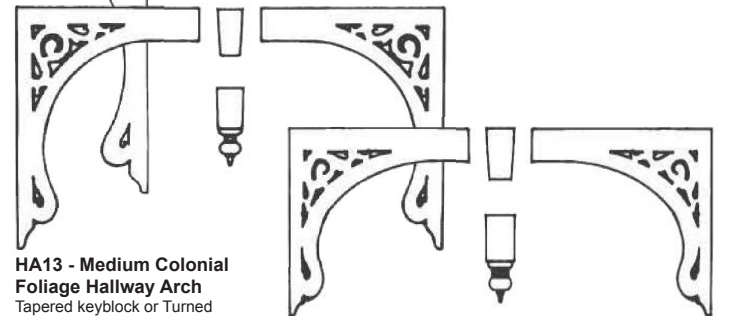

**HA13 - Medium Colonial Foliage Hallway Arch**  
Tapered keyblock or Turned Finial available.

**HA14 - Small Colonial Foliage Hallway Arch**  
Tapered keyblock or Turned Finial available.

**Alternative Arch Foot Designs**  
(custom made products only)

Standard foliage foot    Foot 2    Foot 3    Foot 4    Foot 5 Turned Foot Add \$20

**compare our prices!**

**OUR PRICES INCLUDES GST**

# 15 HALLWAY ARCHES

The current version of this document is on the internet. Printed version & prices may be superseded. All material subject to copyright.

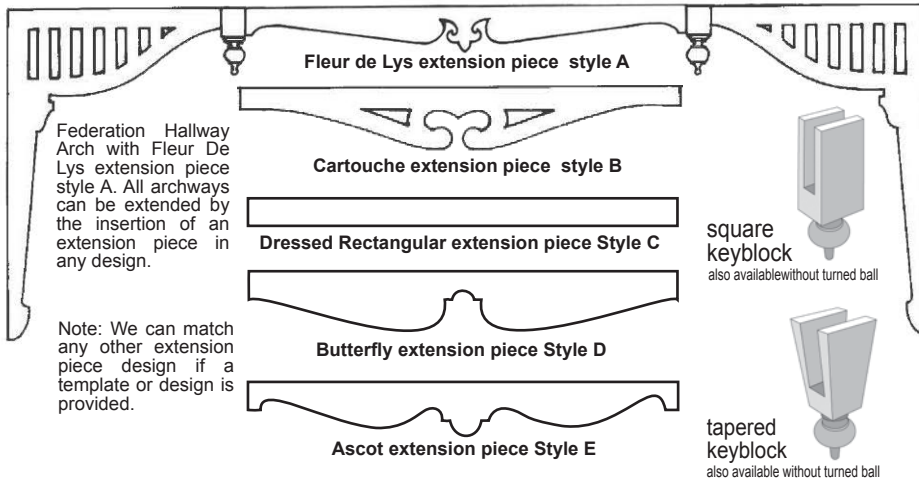

Federation Hallway Arch with Fleur De Lys extension piece style A. All archways can be extended by the insertion of an extension piece in any design.

Note: We can match any other extension piece design if a template or design is provided.

the leg of the arch or extension piece can be trimmed back to suit the width of the opening and the joint is concealed behind the keyblock.

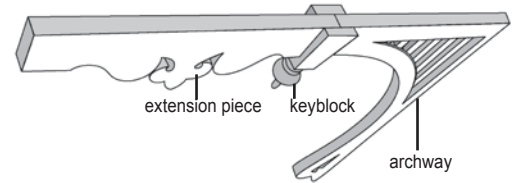

For wider openings the arch is split in the centre and an extension piece is added to the width required. The joints are covered by the keyblocks. There are a range of extension piece designs available to individualize the arch or match other details pre existing in the house.

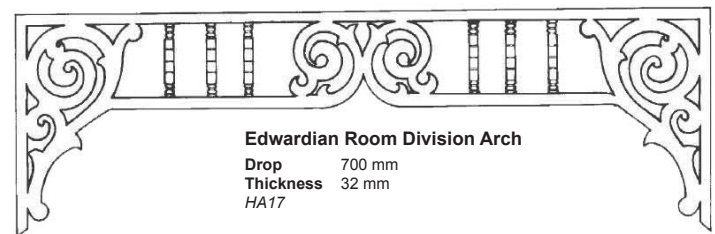
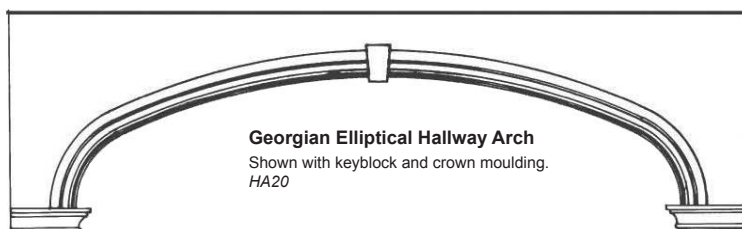
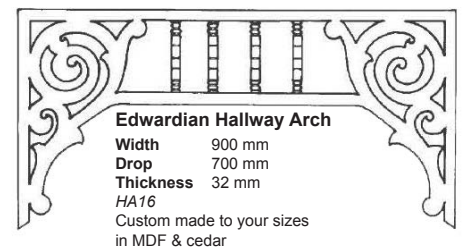
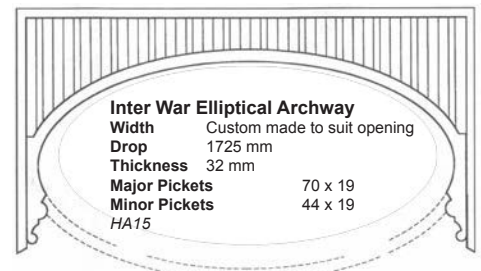
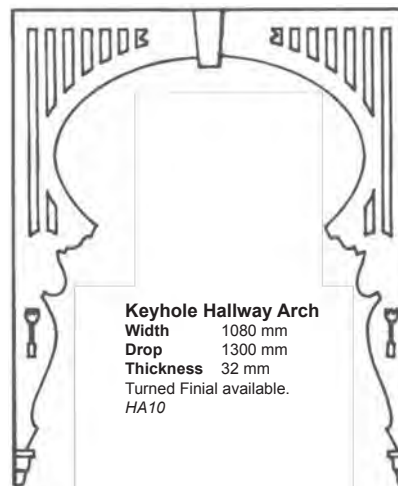
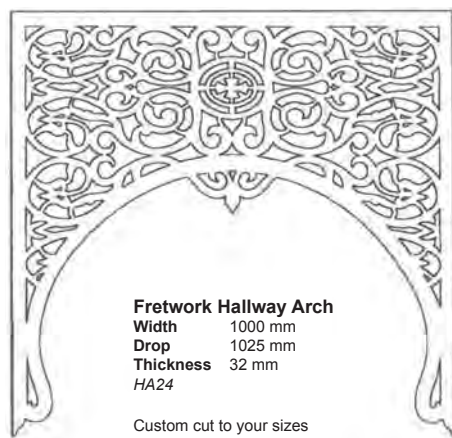
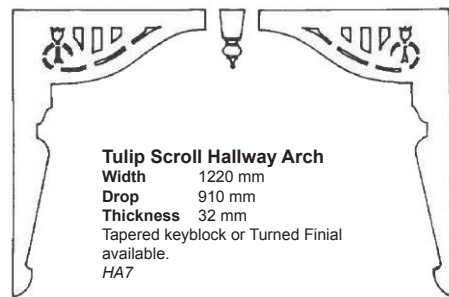
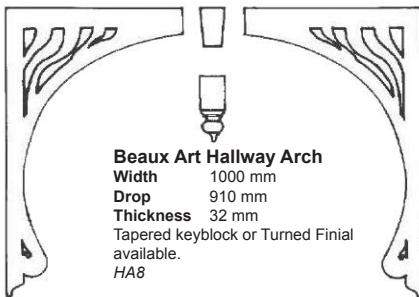
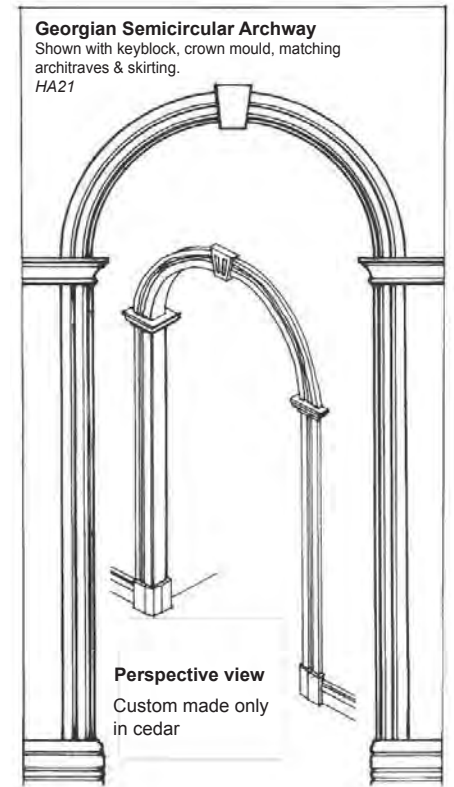
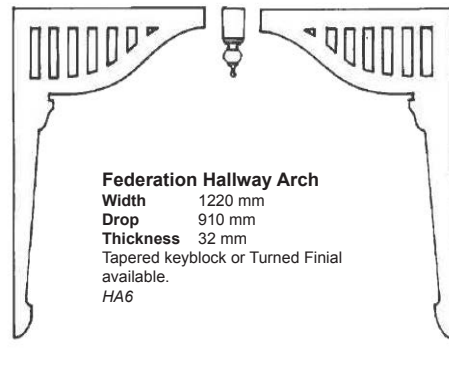

# 15 VERANDAH BRACKETS

The current version of this document is on the internet. Printed version & prices may be superseded. All material subject to copyright.

All bracket prices in our product catalogue

## 1800 to 1900 Queensland Colony Brackets

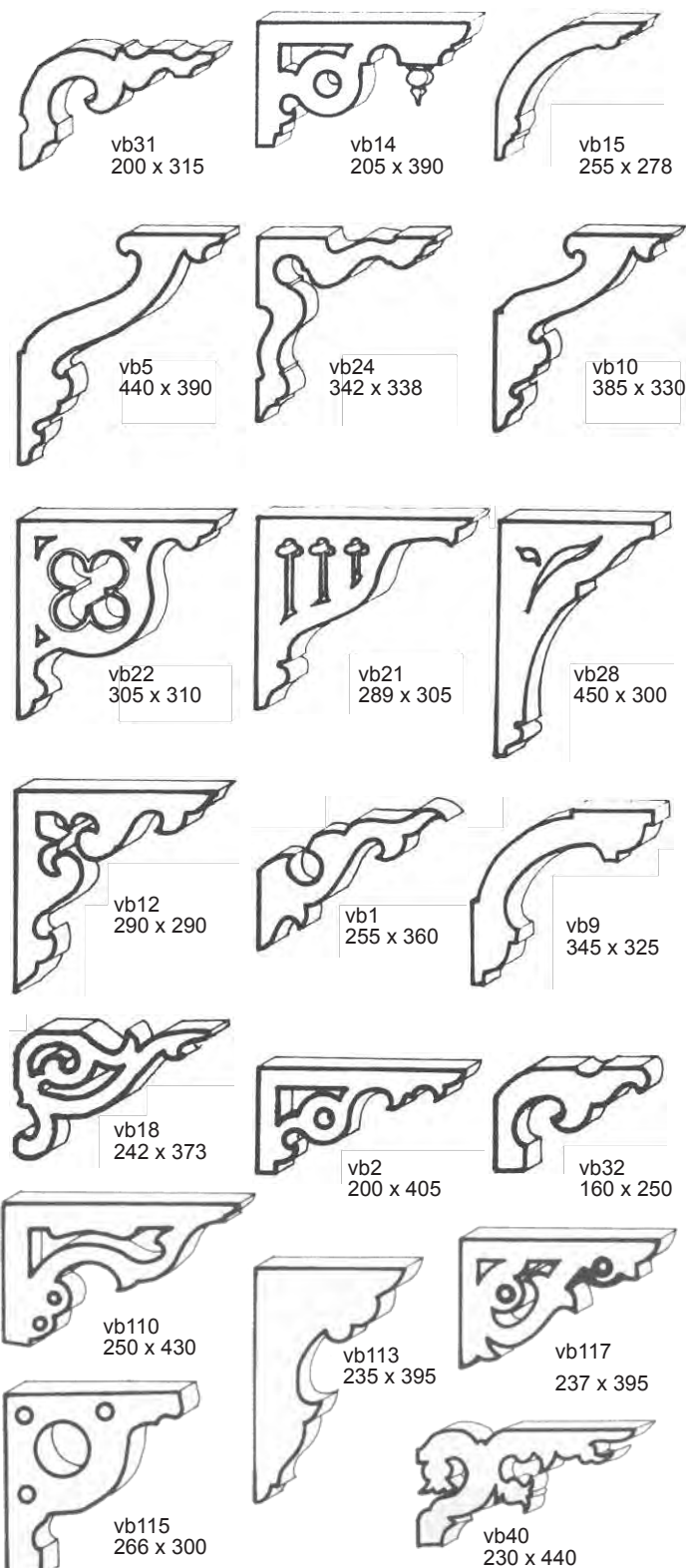

## 1895 to 1914 Art Nouveau Brackets

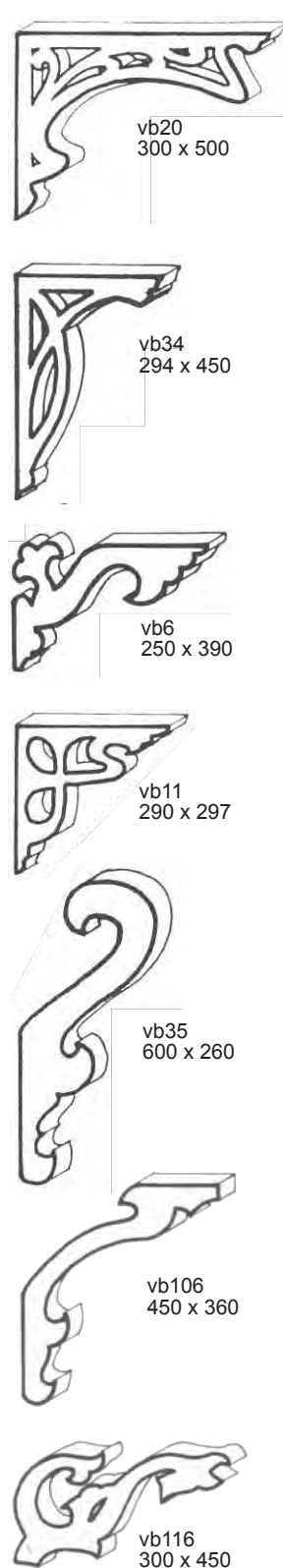

## 1900 to 1918 Federation Pre World War I

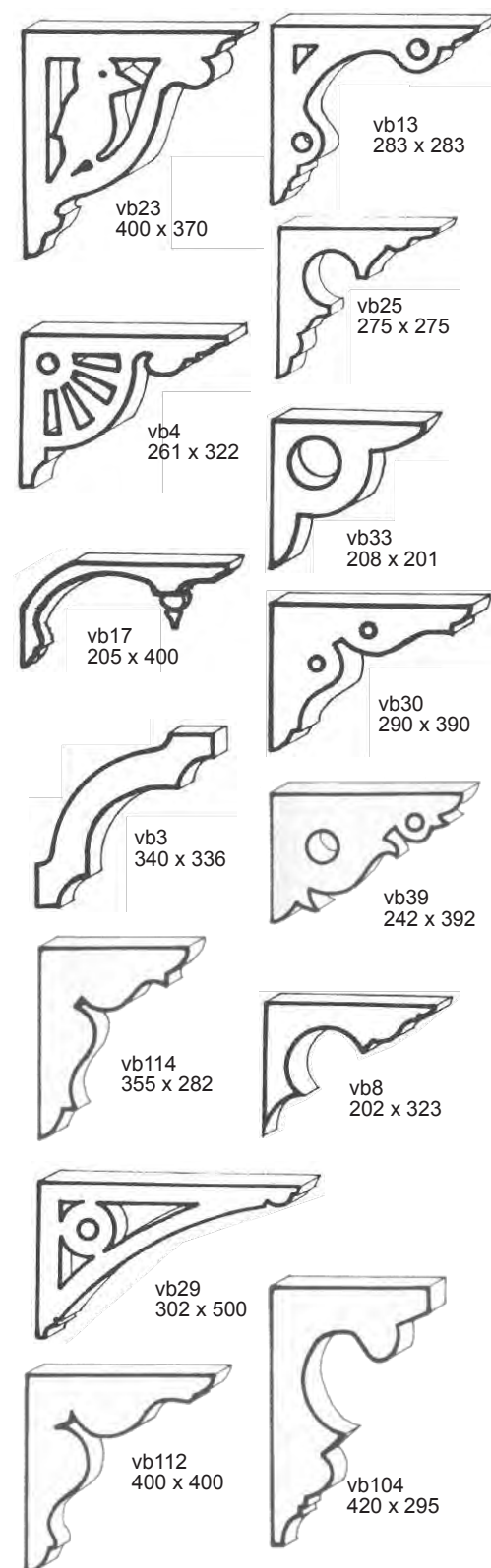

*we reckon we've cut every design ever put on an old house*



**BRISBANE**  
1095 Ipswich Rd  
Mooroooka 4105  
☎ 07 3848 1383  
F: 07 3892 1476

**GOLD COAST**  
Warehouse Road  
Southport 4215  
☎ 07 5571 0088  
F: 07 5571 0617

**SUNCOAST**  
53 Wisers Road  
Maroochydore  
☎ 07 5479 0999  
F: 07 5479 0911

**SYDNEY**  
2 Sydenham Rd  
Brookvale 2100  
☎ 02 9938 4999  
F: 02 9938 4666

# 15 VERANDAH BRACKETS

The current version of this document is on the internet. Printed version & prices may be superseded. All material subject to copyright.

## 1920 to 1935 Pre World War II Brackets

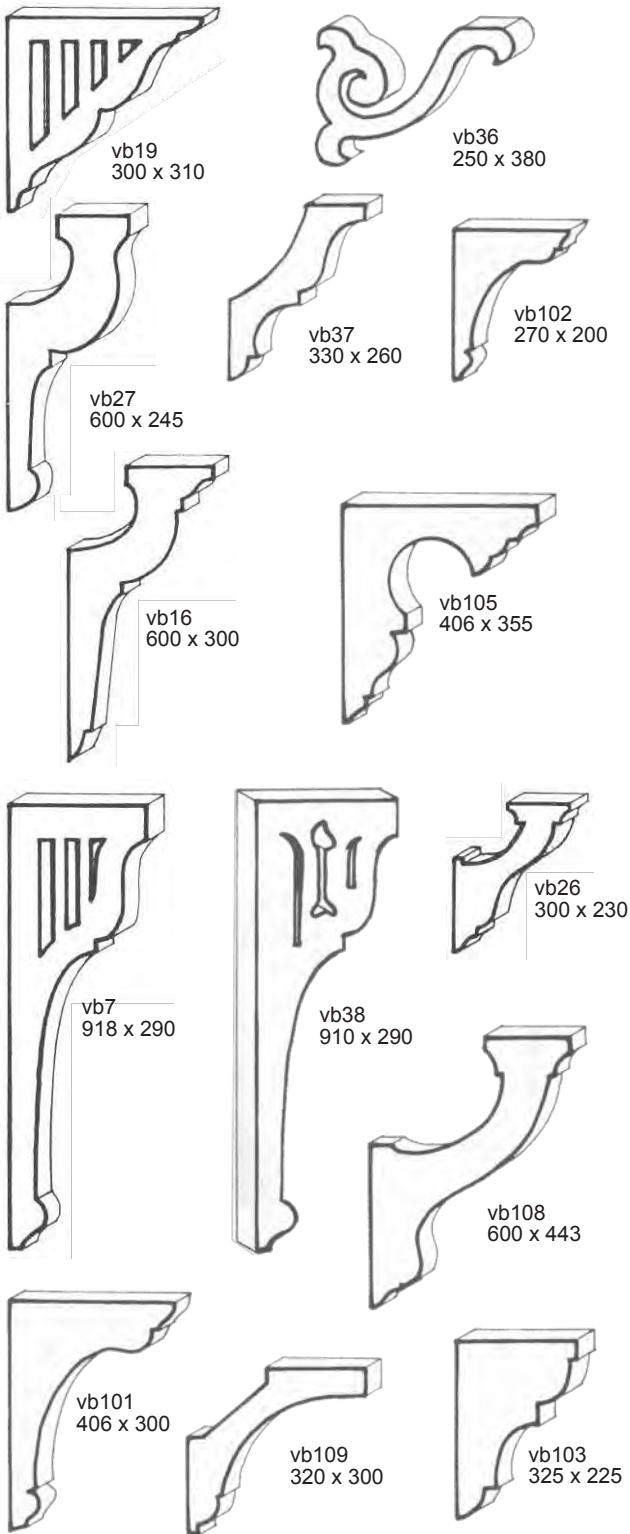

## Eaves and Shelf Brackets

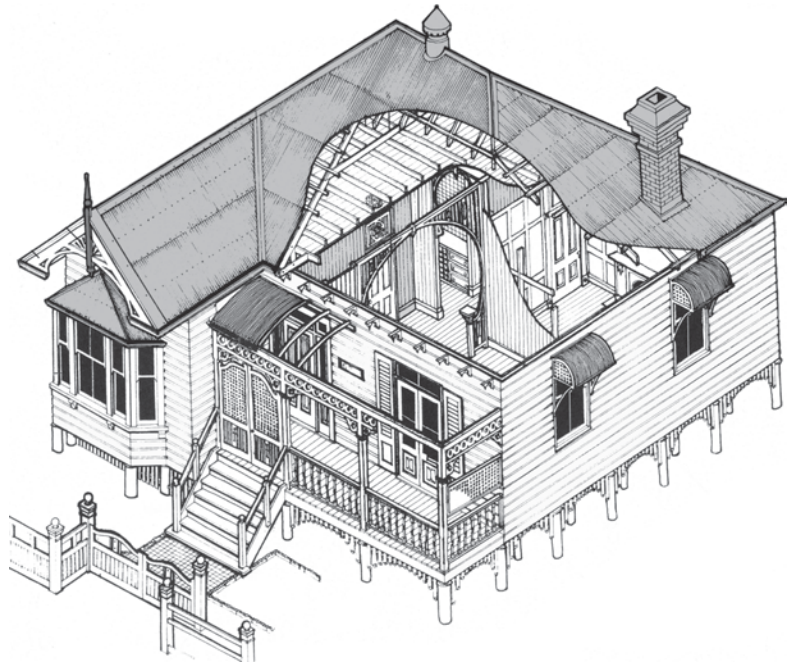
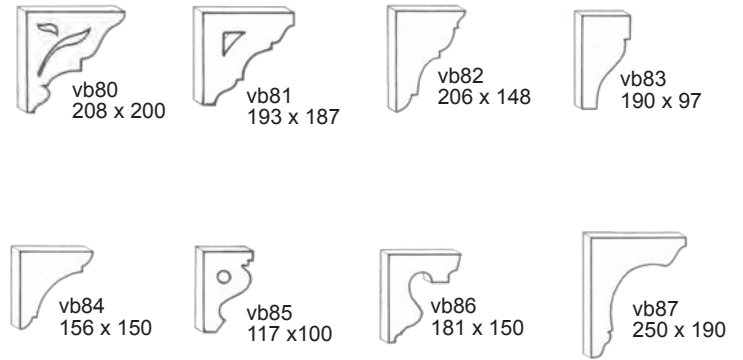

### Verandah Archways

Cut from solid timber to suit openings for internal and external applications. Circular and elliptical profiles shown.

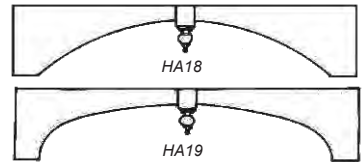

### Fretworked Verandah Archways

Cut in Weathertex with solid timber curved bottom rail.



**we can custom make  
any design required.**

**BRISBANE**  
1095 Ipswich Rd  
Moorooka 4105  
☎ 07 3848 1383  
F: 07 3892 1476

**GOLD COAST**  
Warehouse Road  
Southport 4215  
☎ 07 5571 0088  
F: 07 5571 0617

**SUNCOAST**  
53 Wisers Road  
Maroochydore  
☎ 07 5479 0999  
F: 07 5479 0911

**SYDNEY**  
2 Sydenham Rd  
Brookvale 2100  
☎ 02 9938 4999  
F: 02 9938 4666